

Infire Concept 790 DF / DK



Infire Concept 790 DF / DK

Puissance - vermogen (kW)		11
Rendement (%)		79,9
CO (mg/Nm ³)		1190
Particules PM uitstoot (mg/Nm ³)		22
COG (mg/Nm ³)		81
NOX (mg/Nm ³)		103
Longueur / Lengte		790
Hauteur / Hoogte		603
Profondeur / Diepte		512
Sortie de fumée / Rookuitlaat		Ø200
Prise d'air extérieure / Externe luchttoevoer		Ø125
Homologations - goedkeuring - homologation	Phase III KB 12/10/10 (Belgique) - Flamme verte 7*/ Groene Vlam Indice environnemental/milieu index : 0,4-0,5(France) EN132229 (standard Européen)	
Rapport d'essai - Testrapport (SGS Nederland)	ZKA/2023-10/00002-3	
Déclaration de performance - Prestatie- verklaring	DOP37OP5194-V2	

Option - Opties

Intérieur / Binnenbekleding	Vermiculite / Vermiculiet	✓
	Métal / Metaal	€
Cadre - kader - frame	4 mm	✓
	30 mm	✓
Kit pare-bûches / Kit blokkenhouder		€
Kit ventilation classique + airstat / Kit klassieke ventilatie + airstat		€

Intérieur / Binnenbekleding :

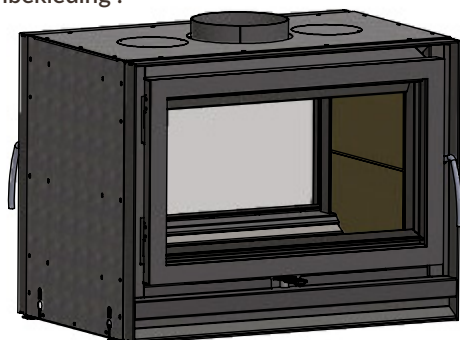

Vermiculite / Vermiculiet

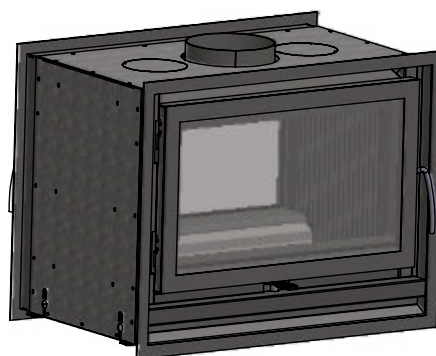

Métal / Metaal

DIMENSIONS AFMETINGEN

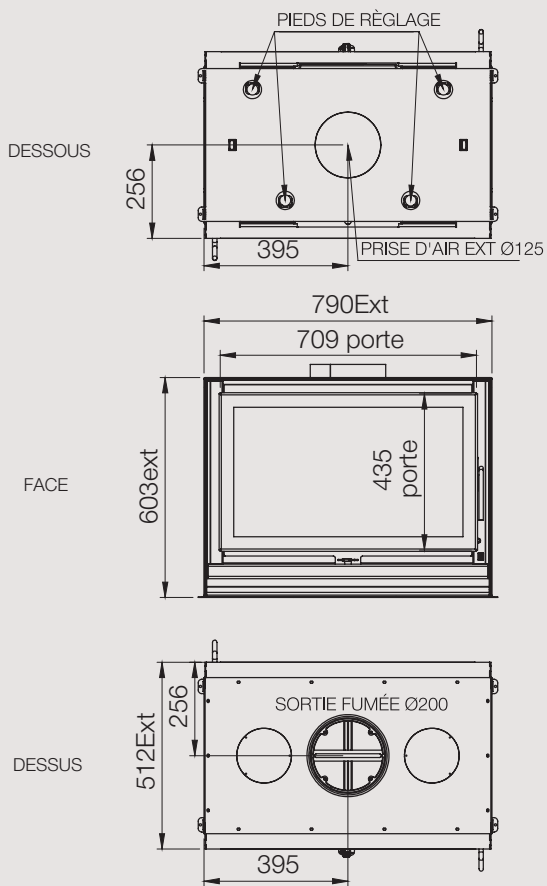

CADRE 4mm

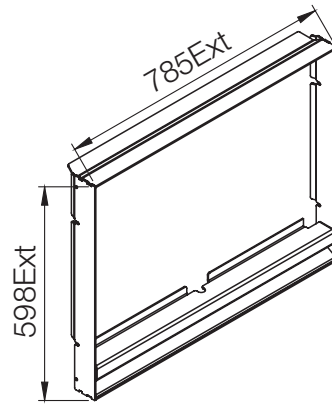

CADRE 30mm

