

# Infire Concept 790



## Infire Concept 790

Puissance - vermogen (kW)		10,5
Rendement (%)		85,8
CO (mg/Nm <sup>3</sup> )		952
Particules PM uitstoot (mg/Nm <sup>3</sup> )		26
COG (mg/Nm <sup>3</sup> )		56
NOX (mg/Nm <sup>3</sup> )		96
<b>Longueur / Lengte</b>		790
<b>Hauteur / Hoogte</b>		603
<b>Profondeur / Diepte</b>		470
<b>Sortie de fumée / Rookuitlaat</b>		Ø200
<b>Prise d'air extérieure / Externe luchttoevoer</b>		Ø125
Homologations - goedkeuring - homologation	Phase III KB 12/10/10 (Belgique) - Flamme verte 7*/ Groene Vlam Indice environnemental/milieu index : 0,4-0,5(France) EN132229 (standard Européen)	
Rapport d'essai - Testrapport (SGS Nederland)	ZKA/2023-10/00002-3	
Déclaration de performance - Prestatie- verklaring	DOP37OP5194-V2	

## Option - Opties

Intérieur / Binnenbekleding	Vermiculite / Vermiculiet	✓
	Métal / Metaal	€
Cadre - kader - frame	4 mm	✓
	30 mm	✓
Kit pare-bûches / Kit blokkenhouder		€
Kit ventilation classique + airstat / Kit klassieke ventilatie + airstat		€

Intérieur / Binnenbekleding :

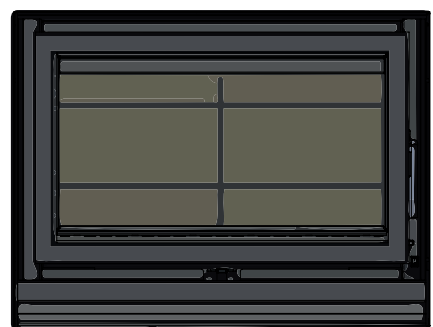

Vermiculite / Vermiculiet

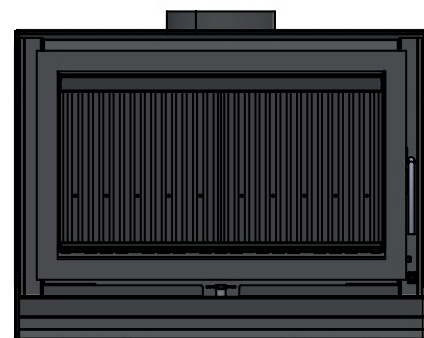

Métal / Metaal

# DIMENSIONS AFMETINGEN

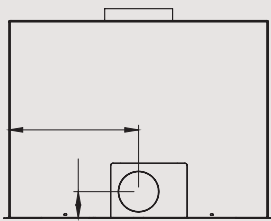
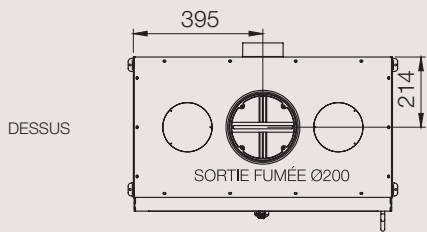
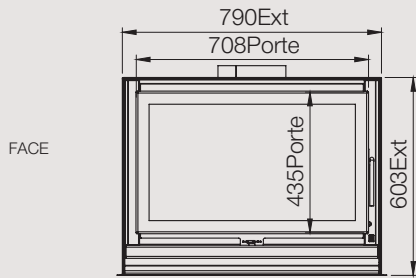
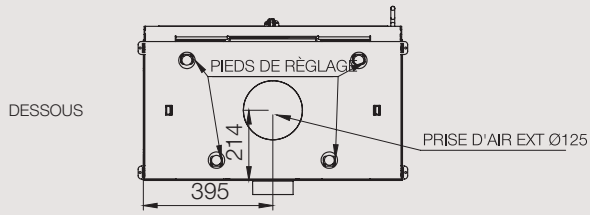

PRISE D'AIR EXT Ø125

CADRE 4mm

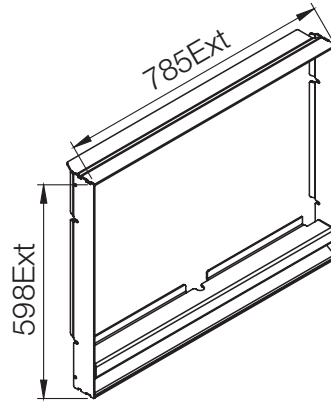

CADRE 30mm

